

# IN-STOCK RANGE FOR 2020

---

INTERNATIONAL



**Glatz**  
Shade in Swiss Quality

## *easy collection*

With our in-stock *easy* collection, we offer sun protection with maximum functionality and quality to budget-conscious customers and impulse buyers—only the selection of colours and fabrics is limited. All models of the *easy* collection are in stock at our distribution partners. They are easy to handle and set up in no time.

## *Light fastness*

Not only skin, but also sunshade covers must be protected from strong UV rays. If a sunshade is permanently exposed to the sun, the material will fade over time. How quickly and to what extent depends on the quality of the fabric. The GLATZ *easy* collection

stands up to it with material class 2. Even in constant, direct sunlight, it has an open air resistance lifespan of 40–80 days.

## *UV protection*

Every sunshade offers protection from the sun, but not all protect you from its dangerous ultraviolet (UV) rays. Although only a fraction of their solar radiation reaches the earth, UV rays are harmful to the skin because of their intensity.

According to Germany's Federal Office for Radiation Protection (BfS), UV rays are subdivided into the wavelength ranges UV-A (315–400 nm), UV-B (280–320 nm) and UV-C (100–280 nm). Whilst UV-C radiation is completely absorbed by the earth's upper atmosphere, UV-A and UV-B rays penetrate all the way to the earth's surface. It is the energy of UV-B rays that has a particularly severe effect on the skin, not only causing symptoms such as sunburn but also increasing the risk of skin aging and skin cancer.

All GLATZ sunshade fabric covers carry the "UVPROTECTION" testing label: The percentage indicated on the label is derived from the UPF rating and calculated on the basis of the data determined by the Swiss accredited test laboratory SQTS using the following formula:

$$\text{PERCENTAGE} = 100 - 100/\text{UPF (SQTS)}$$

In other words: if 99 per cent of the direct UV rays are filtered out by the fabric, only 1 per cent—i.e. one hundredth—can penetrate it and reach the skin. As a result, with GLATZ's UV protection it takes 100 times longer for the skin to absorb the same dose of radiation than without UV protection. This factor of a hundred is defined as the sun protection factor.

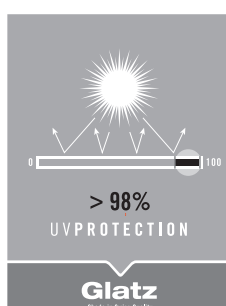

## Point of use



**Hotel & Restaurant:** This sunshade model is particularly suitable for the everyday demands of hotels and restaurants. It can be combined with other models of different colours, shapes and sizes.



**Meadow:** This functional and robust sunshade model is highly recommended for large and small lawns.



**Terrace:** Whether your terrace is large, small, square or rectangular, this model adapts to its surroundings and sets the perfect tone in your outdoor area.



**Balcony:** This model puts every last corner of the balcony in the shade and takes up almost no space thanks to its design.

## Fastenings



**Base:** This sunshade type can be attached to a base or a weighted pedestal, so it can be moved at any time without complex installation.



**Ground socket:** If the sunshade model will be fixed in one place, a ground socket set in concrete is the ideal choice.



**Lawn spike:** Thanks to a lawn spike sunk into the ground, this model can be moved very quickly to a new location in the soft ground.



**Balcony wall consoles:** Where space is at a premium, this sunshade model can be fastened to the balcony railing with a wall console.





**Wall console:** Walls are no obstacle to us, because this sunshade model can be easily fastened to them with a wall consoles.



**Advice:** Use original GLATZ accessories for the best possible fastening and stability. This is the only way to guarantee optimum performance and the GLATZ warranty.



# PIAZZINO *easy*



<b>Frame:</b>	8 parts made of hardwood, continuous pole $\varnothing$ 48 mm, with simple pulley system for easy-opening.
<b>Frame material:</b>	hardwood (painted red)
<b>Frame shape:</b>	round or square
<b>Shade cover:</b>	available in the material class 2, colour 150 (100% polyester approx. 220 g/m <sup>2</sup> )
<b>Colour:</b>	<div style="display: flex; align-items: center;"> <div style="background-color: #f0e68c; border-radius: 50%; width: 20px; height: 20px; display: flex; align-items: center; justify-content: center; margin-right: 5px;">150</div> <div>Eggshell</div> </div>
<b>Flounce:</b>	not available
<b>Protective cover</b>	included in the standard equipment
<b>Note:</b>	The wood may secrete colourings and its own natural oils which may leave residues behind on a light coloured cover. This cannot be avoided and is therefore not admissible as a complaint. Wood is a natural product and should not be left in the rain for too long!
<b>Fixations:</b>	<div style="display: flex; gap: 10px;">    </div>



## Assortment PIAZZINO *easy*

	Nominal size without flounce	Number of rods	Material class 2 Colour 150	Order no. Frame hardwood
	cm			
	$\varnothing$ 300	8 parts		172 00 300 751
	$\varnothing$ 350	8 parts		172 00 350 751
	300 x 300	8 parts		172 00 301 751

## Accessories

	Order no.
<b>Fixing option Z</b> (support tube Z absolutely necessary)	
Concrete base Z, 40 kg, $\varnothing$ 60 x 8.5 cm	350 01 109 529
Support tube Z, $\varnothing$ 48 / 55 mm, galvanised steel	350 01 201 210
Concrete base Z, 55 kg, $\varnothing$ 60 x 11 cm	350 01 109 528
Support tube Z, $\varnothing$ 48 / 55 mm, galvanised steel	350 01 201 210
<b>Protective cover made of coated, tear-resistant polyester fabric</b>	
Protective cover with zip and rod	350 01 609 978

Nominal size	Lateral distance	Pole $\varnothing$	Area covered	Height closed	Clear headroom	Total height	Foundation	Minimum weight for base	max. wind speed open perm.
cm	cm	cm	m <sup>2</sup>	cm	cm	cm	cm	kg	km/h (wind force)
A	AS	M	B	E	F	G	C		
$\varnothing$ 300	275	4.8	6.4	95	205	260	60 × 60	40	30 (5)
$\varnothing$ 350	325	4.8	8.7	80	205	270	60 × 60	55	30 (5)
300 × 300	-	4.8	9.0	50	205	275	60 × 60	55	30 (5)

The listed measures represent extrapolated average values that may be slightly different on the product ( $\pm 2\% \pm 5$  cm).  
The height dimensions are based on the ground socket PX. In the base variations these might differ slightly. Apart from the steel base minus 7.5 cm.  
The max. wind speed limits as per our separate list apply only in the presence of a fix ground anchorage.  
In the presence of several sunshades, the minimum distance between one sunshade and another and between sunshades and walls shall be 20 cm.

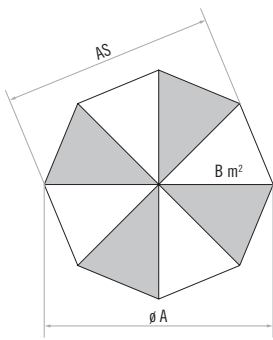

8 parts

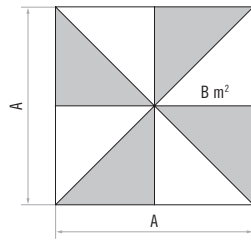

8 parts

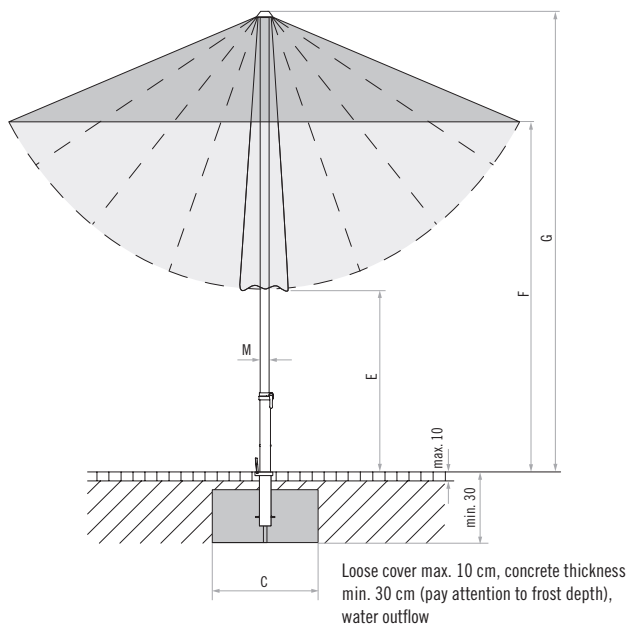

# ALU-SMART *easy*



**Frame:** 6 or 8 rods made of aluminium, anodized natural, with a profiled pole and stepless height adjustment. Upper pole 38.4 × 1.2 mm – lower pole 35 × 1.5 mm, tilting thanks to the tilt joint.

**Frame material:** anodized natural

**Frame shape:** round, rectangular or square

**Shade cover:** available in material class 2 (100% polyester approx. 220 g/m<sup>2</sup>)

**Colours:**



**Flounce:** not available

**Protective cover:** optional

**Fixations:**



ALU-SMART, Int. Patents reg. © Int. Design reg.



## Assortment ALU-SMART *easy*

	Nominal size without flounce	Number of rods	Material class 2 Colours: 127/146 150/151/162	Order no.
				Frame anodized natural
	cm			
	∅ 200	6 parts		206 00 200 171
	∅ 220	8 parts		206 00 220 171
	∅ 250	8 parts		206 00 250 171
	∅ 300	8 parts		206 00 300 171
	210 × 150	6 parts		206 00 212 171
	250 × 200	6 parts		206 00 252 171
	200 × 200	8 parts		206 00 201 171
	240 × 240	8 parts		206 00 241 171

## Accessories

	Order no.
<b>Fixing option Z</b> (support tube Z absolutely necessary)	
Concrete base Z, 40 kg, ∅ 60 × 8.5 cm	350 01 109 529
Support tube Z, ∅ 35 / 38 – 39 mm, galvanised steel	350 01 201 100
<sup>3</sup> Granite base Z, 40 kg, 45 × 45 × 8 cm, natural stone, with castors and retractable handle	350 01 109 465
Support tube Z, ∅ 35 / 38 – 39 mm, high-grade steel 1.4301 / 304	350 01 201 100
<b>Different fixing options</b>	
Wall consoles U for the table top, ∅ 31 – 40 mm, high-grade steel 1.4301 / 304, for horizontal flat railing, square profile up to 120 mm	350 01 252 005
<b>Protective cover made of coated, tear-resistant polyester fabric</b>	
Protective cover with zip and rod	350 01 609 980
<b>Miscellaneous items</b>	
Rechargeable battery light Osyrion 4 for pole ∅ 30 – 50 mm, battery charger with european plug (type C) included 1 accumulator included	350 01 557 910
Spare accu, 3.6 V, 2500 mAh (for Osyrion 4 & 6)	350 01 557 920

<sup>3</sup> only suitable for smooth, joint free surface coverings

Nominal size	Lateral distance	Pole $\emptyset$	Area covered	Height closed	Clear headroom	Total height	Clearance height, sunshade part inclined	Total height, sunshade inclined	Foundation	Minimum weight for base	max. wind speed open perm.
cm	cm	cm	m <sup>2</sup>	cm	cm	cm	cm	cm	cm	kg	km/h (wind force)
A	AS	M	B	E	F	G	K	L	C		
$\emptyset$ 200	175	3.5	2.6	70...130	150...210	180...240	95...155	200...260	40 × 40	30	75 (9)
$\emptyset$ 220	205	3.5	3.4	65...125	150...210	180...240	90...150	205...265	40 × 40	30	65 (8)
$\emptyset$ 250	230	3.5	4.4	50...110	150...210	185...245	80...140	217...275	50 × 50	40	50 (7)
$\emptyset$ 300	275	3.5	6.4	50...90	170...210	210...250	85...125	245...285	60 × 60	40	35 (5)
210 × 150	-	3.5	3.2	50...110	150...210	185...245	110...170	190...250	40 × 40	30	55 (7)
250 × 200	-	3.5	5.0	40...80	170...210	210...250	110...150	220...260	50 × 50	40	40 (6)
200 × 200	-	3.5	4.0	35...95	150...210	185...245	95...155	200...260	40 × 40	40	50 (7)
240 × 240	-	3.5	5.8	30...70	170...210	210...250	100...140	230...270	50 × 50	40	40 (6)

The listed measures represent extrapolated average values that may be slightly different on the product ( $\pm 2\% \pm 5$  cm).

Height dimensions are based on ground socket BT. These vary slightly depending on the type of base. Except for steel base minus 5 cm.

The max. wind speed limits as per our separate sheet apply only if the sunshade canopy is in a horizontal position and if there is a fix ground anchorage.

In the presence of several sunshades, the minimum distance between one sunshade and another and between sunshades and walls shall be 20 cm.

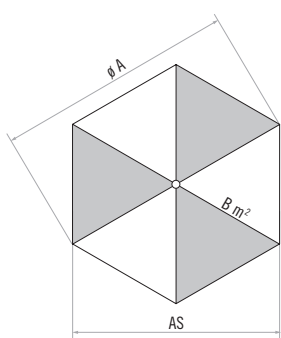

6 parts

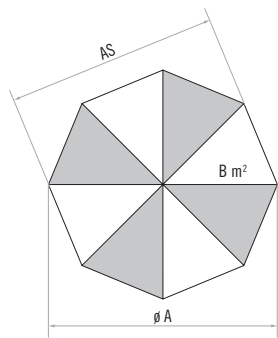

8 parts

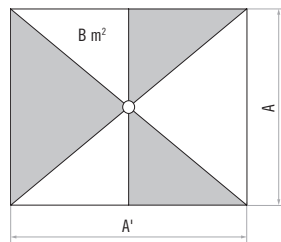

6 parts

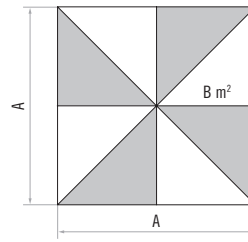

8 parts

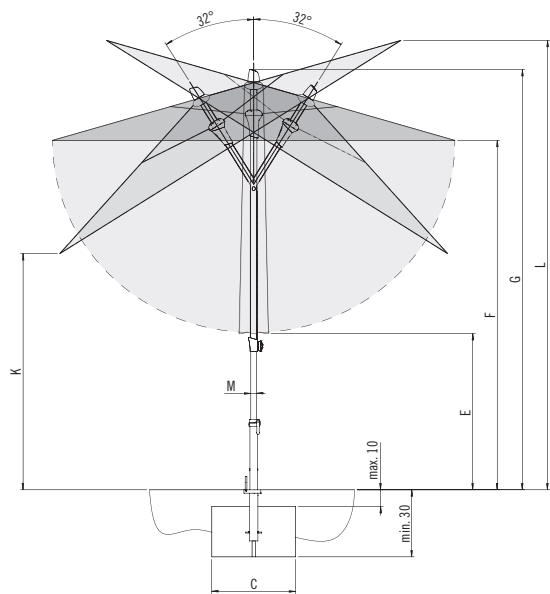

Loose cover max. 10 cm, concrete thickness min. 30 cm  
(pay attention to frost depth), water outflow

# ALU-TWIST *easy*



**Frame:** 6 or 8 rods made of aluminium, anodized natural, with a profiled pole – upper pole 38.4 × 1.2 mm – lower pole 39 × 1.5 mm, with crank mechanism for easy opening and “twist” mechanism for stepless tilting.

**Frame material:** anodized natural

**Frame shape:** round, rectangular or square

**Shade cover:** available in material class 2 (100 % polyester approx. 220 g/m<sup>2</sup>)

**Colours:**

Kiwi	Bright yellow	Eggshell	Ash	Chili

**Flounce:** not available

**Protective cover:** optional

**Fixations:**

ALU-TWIST, © Int. Design reg.



## Assortment ALU-TWIST *easy*

	Nominal size without flounce	Number of rods	Material class 2 Colours: 127/146 150/151/162	Order no.
				Frame anodized natural
	cm			
	∅ 270	8 parts		204 00 270 171
	∅ 300	8 parts		204 00 300 171
	∅ 330	8 parts		204 00 330 171
	210 × 150	6 parts		204 00 213 171
	250 × 200	6 parts		204 00 253 171
	240 × 240	8 parts		204 00 241 171

## Accessories

	Order no.
<b>Fixing option Z</b> (support tube Z absolutely necessary)	
Concrete base Z, 40 kg, ∅ 60 × 8.5 cm	350 01 109 529
Support tube Z, ∅ 35 / 38 – 39 mm, galvanised steel	350 01 201 010
Concrete base Z, 55 kg, ∅ 60 × 11 cm	350 01 109 528
Support tube Z, ∅ 35 / 38 – 39 mm, galvanised steel	350 01 201 010
<sup>3</sup> Granite base Z, 40 kg, 45 × 45 × 8 cm, natural stone, with castors and retractable handle	350 01 109 465
<sup>3</sup> Granite base Z 55 kg, 55 × 55 × 9 cm, natural stone, with castors and retractable handle	350 01 109 445
Support tube Z, ∅ 35 / 38 – 39 mm, high-grade steel 1.4301 / 304	350 01 201 100
<b>Different fixing options</b>	
Wall consoles U for the table top, ∅ 31 – 40 mm, high-grade steel 1.4301 / 304, for horizontal flat railing, square profile up to 120 mm	350 01 252 005
<b>Protective cover made of coated, tear-resistant polyester fabric</b>	
Protective cover with zip and rod	350 01 609 980
<b>Miscellaneous items</b>	
Rechargeable battery light Osyrion 4 for pole ∅ 30 – 50 mm, battery charger with european plug (type C) included 1 accumulator included	350 01 557 910
Spare accu, 3.6 V, 2500 mAh (for Osyrion 4 & 6)	350 01 557 920

<sup>3</sup> only suitable for smooth, joint free surface coverings



Nominal size	Lateral distance	Pole $\varnothing$	Area covered	Height closed	Clear headroom	Total height	Foundation	Minimum weight for base	max. wind speed open perm.
cm	cm	cm	m <sup>2</sup>	cm	cm	cm	cm	kg	km/h (wind force)
A	AS	M	B	E	F	G	C		
$\varnothing$ 270	250	3.9	5.2	110	205	260	50 × 50	40	30 (5)
$\varnothing$ 300	275	3.9	6.4	105	205	265	60 × 60	40	25 (4)
$\varnothing$ 330	305	3.9	7.7	95	205	275	60 × 60	55	25 (4)
210 × 150	-	3.9	3.2	105	205	245	50 × 50	40	30 (5)
250 × 200	-	3.9	5.0	85	205	260	50 × 50	40	25 (4)
240 × 240	-	3.9	5.8	75	205	255	50 × 50	40	25 (4)

The listed measures represent extrapolated average values that may be slightly different on the product ( $\pm 2\% \pm 5$  cm). Traditionally, the nominal dimension is calculated by doubling the rod length. For this reason, the nominal dimension can exceed the specified tolerance range. Height dimensions are based on ground socket BT. These vary slightly depending on the type of base. Except for steel base minus 5 cm. The max. wind speed limits as per our separate sheet apply only if the sunshade canopy is in a horizontal position and if there is a fix ground anchorage. In the presence of several sunshades, the minimum distance between one sunshade and another and between sunshades and walls shall be 20 cm.

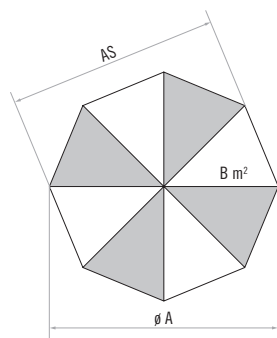

8 parts

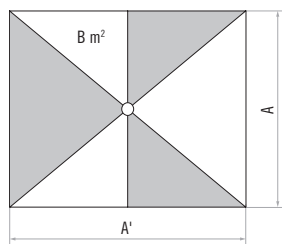

6 parts

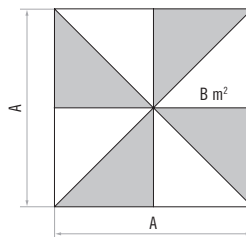

8 parts

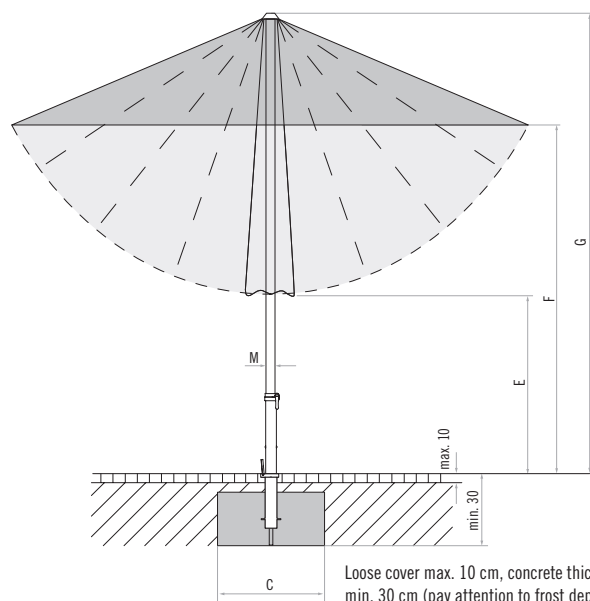

# FORTINO® *easy*



**Frame:** 8 rods made of natural anodized aluminium, 100 % inox, screws and rivets of high-grade steel, two-part profiled pole 38.4 × 2 mm, contrarotating opening system allowing for easy opening.

**Frame material:** anodized natural

**Frame shape:** round or square

**Shade cover:** available in material class 2 (100 % polyester approx. 220 g/m<sup>2</sup>)

**Colours:** 150  
Eggshell

**Flounce:** not available

**Protective cover:** optional

**Fixations:**

FORTINO®, © Int. Design reg.



## Assortment FORTINO® *easy*

	Nominal size without flounce cm	Number of rods	Material class 2 Colours 150	Order no.
				Frame anodized natural
○	∅ 250	8 parts		310 00 250 171
	∅ 300	8 parts		310 00 300 171
□	200 × 200	8 parts		310 00 201 171
	240 × 240	8 parts		310 00 241 171

## Accessories

	Order no.
<b>Fixing option Z (support tube Z absolutely necessary)</b>	
Concrete base Z, 55 kg, ∅ 60 × 11 cm	350 01 109 528
Support tube Z, ∅ 35 / 38 – 39 mm, galvanised steel	350 01 201 010
Concrete base Z, 70 kg, ∅ 75 × 9 cm	350 01 109 527
Support tube Z, ∅ 35 / 38 – 39 mm, galvanised steel	350 01 201 010
<sup>3</sup> Granite base Z, 55 kg, 55 × 55 × 9 cm, natural stone, with castors and retractable handle	350 01 109 445
Support tube Z, ∅ 35 / 38 – 39 mm, high-grade steel 1.4301 / 304	350 01 201 100
<b>Protective cover made of coated, tear-resistant polyester fabric</b>	
Protective cover with zip and rod	350 01 609 980

<sup>3</sup> only suitable for smooth, joint free surface coverings

Nominal size	Lateral distance	Pole $\emptyset$	Area covered	Height closed	Clear headroom	Total height	Height open	Foundation	Minimum weight for base	max. wind speed open perm.
cm	cm	cm	m <sup>2</sup>	cm	cm	cm	cm	cm	kg	km/h (wind force)
A	AS	M	B	E	F	G	H	C		
$\emptyset$ 250	230	3.8	4.4	155	205	290	260	60 × 60	55	80 (9)
$\emptyset$ 300	275	3.8	6.4	140	205	305	265	70 × 70	70	60 (7)
200 × 200	-	3.8	4.0	130	205	280	245	60 × 60	55	70 (8)
240 × 240	-	3.8	5.8	115	205	295	250	70 × 70	70	60 (7)

The listed measures represent extrapolated average values that may be slightly different on the product ( $\pm 2\% \pm 5$  cm).

Height dimensions are based on ground socket BT. These vary slightly depending on the type of base. Except for steel base minus 5 cm.

The max. wind speed limits as per our separate list apply only in the presence of a fix ground anchorage.

In the presence of several sunshades, the minimum distance between one sunshade and another and between sunshades and walls shall be 20 cm.

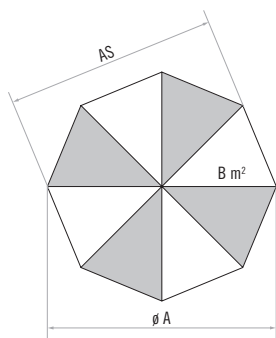

8 parts

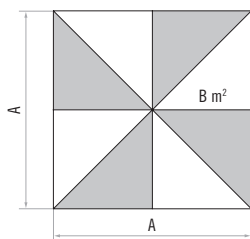

8 parts

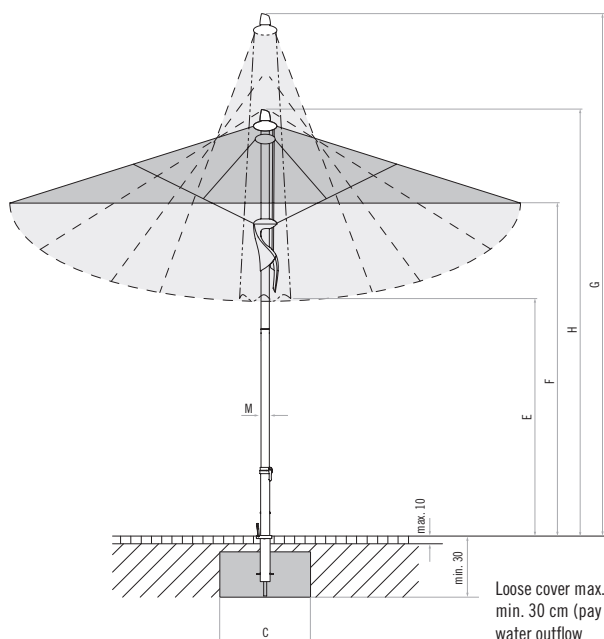

Loose cover max. 10 cm, concrete thickness min. 30 cm (pay attention to frost depth), water outflow



**Frame:** 8 rods made of natural anodized aluminium, 100 % inox, screws and rivets of high-grade steel, two-part profiled pole 55 × 2.5 mm, contrarotating opening system allowing for easy opening.

**Frame material:** anodized natural

**Frame shape:** round, rectangular or square

**Shade cover:** available in material class 2 (100 % polyester approx. 220 g/m<sup>2</sup>)

**Colours:** 150  
Eggshell

**Flounce:** not available

**Protective cover:** optional

**Fixations:**



FORTERO®, © Int. Design reg.

## Assortment FORTERO® *easy*

	Nominal size	Number of rods	Material class 2	Order no.
	without flounce			
	cm		150	anodized natural
	∅ 350	8 parts		320 00 350 171
	∅ 400	8 parts		320 00 400 171
	300 × 200	8 parts		320 00 302 171
	350 × 250	8 parts		320 00 352 171
	250 × 250	8 parts		320 00 251 171
	300 × 300	8 parts		320 00 301 171
	350 × 350	8 parts		320 00 351 171

## Accessories

	Order no.
<b>Fixing option Z</b> (support tube Z absolutely necessary)	
Concrete base Z, 70 kg, ∅ 75 × 9 cm	350 01 109 527
Support tube Z, ∅ 48 / 55 mm, galvanised steel	350 01 201 210
Concrete base Z, 90 kg, ∅ 75 × 11 cm	350 01 109 523
Support tube Z, ∅ 48 / 55 mm, galvanised steel	350 01 201 210
Natural granite base Z, 90 kg, 64 × 64 × 9 cm, natural stone	350 01 109 515
Support tube Z, ∅ 48 / 55 mm, high-grade steel 1.4301 / 304	350 01 201 300
<b>Fixing option M4</b> (support tube M4 absolutely necessary)	
Base M4, 120 kg, (for 8 plates 40 × 40 × 4 cm), 91 × 91 × 11.5 - 15.5 cm, galvanised steel (adjustable and levellable) (price without plates)	350 01 108 235
Support tube M4, ∅ 48 / 55 mm, galvanised steel	350 01 200 035
Slab set, 8 pieces, 40 × 40 × 4 cm, (ca. 110 kg), concrete	350 01 226 908
Cover for base M4, 88 × 88 × 5 cm, brushed aluminium (imitation)	350 01 100 400
Set of castors for base M4 (maximum weight 240kg), ∅ 5 cm, H = 5.5 cm, galvanised steel	350 01 100 500
<b>Protective cover made of coated, tear-resistant polyester fabric</b>	
Protective cover with zip and rod	350 01 609 981
<b>Miscellaneous items</b>	
Bistro table (silvergry)	350 01 900 100

Nominal size	Lateral distance	Pole $\varnothing$	Area covered	Height closed	Clear headroom	Total height	Height open	Foundation	Minimum weight for base	max. wind speed open perm.
cm	cm	cm	m <sup>2</sup>	cm	cm	cm	cm	cm	kg	km/h (wind force)
A	AS	M	B	E	F	G	H	C		
$\varnothing$ 350	325	5.5	8.7	125	205	310	260	70 × 70	90	55 (7)
$\varnothing$ 400	370	5.5	11.3	120	205	330	270	80 × 80	120	50 (7)
300 × 200	-	5.5	6.0	120	205	310	260	70 × 70	70	60 (7)
350 × 250	-	5.5	8.8	110	205	335	270	70 × 70	90	55 (7)
250 × 250	-	5.5	6.3	110	205	295	255	70 × 70	70	70 (8)
300 × 300	-	5.5	9.0	95	205	315	260	70 × 70	90	60 (7)
350 × 350	-	5.5	12.3	85	205	345	270	80 × 80	120	50 (7)

The listed measures represent extrapolated average values that may be slightly different on the product ( $\pm 2\% \pm 5$  cm).

Height dimensions are based on ground socket M4. If one of the offered bases is used, these measures raise by 11.5 – 15.5 cm.

The max. wind speed limits as per our separate list apply only in the presence of a fix ground anchorage.

In the presence of several sunshades, the minimum distance between one sunshade and another and between sunshades and walls shall be 20 cm.

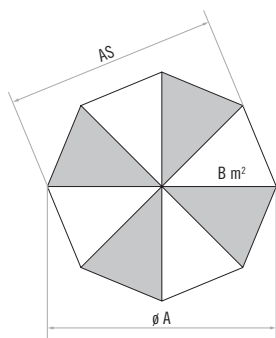

8 parts

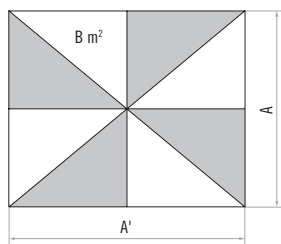

8 parts

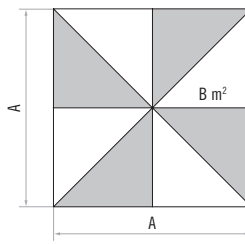

8 parts

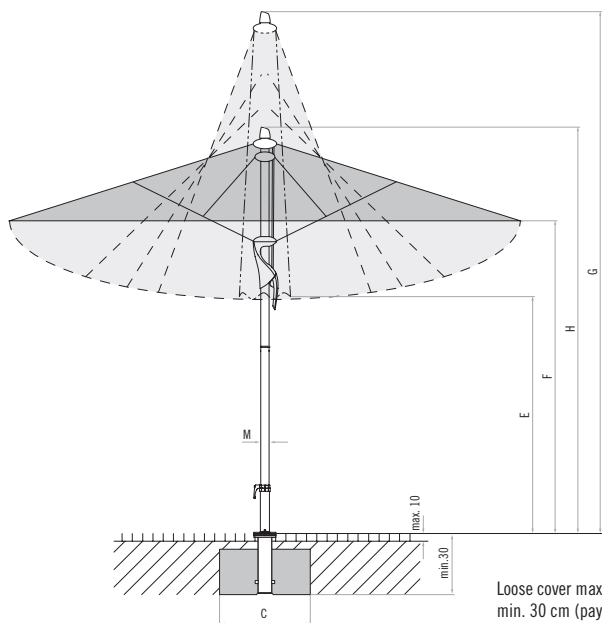

Loose cover max. 10 cm, concrete thickness min. 30 cm (pay attention to frost depth), water outflow

# FORTANO® *easy*



**Frame:** With 8 parts made from aluminium with crank drive. Patent pending opening mechanism for particularly high closing heights. The pole profile is oval 66 × 95 × 3 mm. With hand crank.

**Frame material:** graphite grey powder-coated (RAL 5803 E 90070 A10)

**Frame shape:** rectangular or square

**Shade cover:** available in material class 2 (100 % polyester approx. 220 g/m<sup>2</sup>)

**Colours:** 150  
Eggshell

**Flounce:** not available

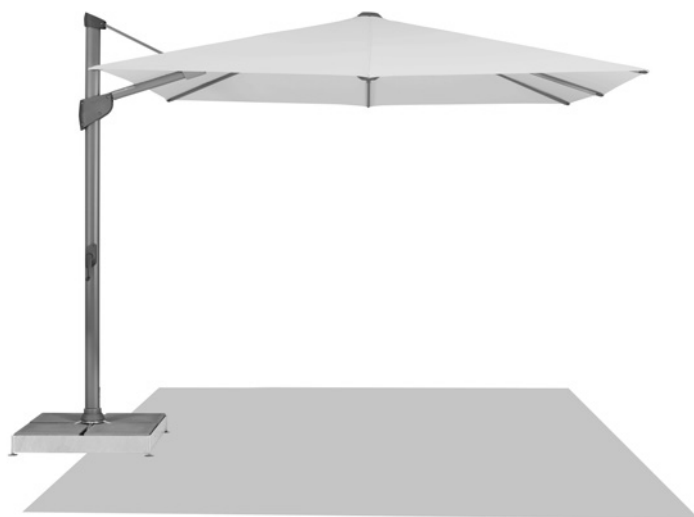

**Protective cover:** included in the standard equipment

**Fixations:** 



FORTANO®, Int. Patents pend.

## Assortment FORTANO® *easy*

	Nominal size without flounce	Number of rods	Material class 2 Colours 150	Order no. Frame graphite grey
	300 × 300	8-teilig		094 00 310 321
	400 × 300	8-teilig		094 00 402 321

Nominal size	Lateral distance	Pole Ø	Area covered	Crank handle height	Height closed	Clear headroom	Total height	Height of pole	Overhang at the back	Length of free-arm	Foundation	Minimum weight for base	max. wind speed open perm.
cm	cm	cm	m <sup>2</sup>	cm	cm	cm	cm	cm	cm	cm	cm	kg	km/h (wind force)
A	AS	M <sup>1</sup>	B	D	E	F	G	M <sup>2</sup>	N	Z	C		
300 × 300	-	6.6 × 9.5	9	106	105	215	320	265	12	175	60 × 60	120	60 (7)
400 × 300	-	6.6 × 9.5	12	106	65	215	320	265	12	175	60 × 60	150	50 (6)

The listed measures represent extrapolated average values that may be slightly different on the product (± 2 % ± 5 cm).

The height dimensions are based on the ground socket M4. With the base M4, 120 kg these vary by plus 11.5 cm and with the base M4, 180 kg by plus 15.5 cm.

The max. wind speed limits as per our separate sheet apply only if the sunshade canopy is in a horizontal position and if there is a fix ground anchorage.

In the presence of several sunshades, the minimum distance between one sunshade and another and between sunshades and walls shall be 20 cm.

## Accessories FORTANO®

	Sales prices	Order no.
<b>³ Base with castors M4 (weight set absolutely necessary)</b>		
Base frame with castors M4, 150 kg, 80 × 80 × 14, galvanised steel		350 01 103 000
Cast concrete decor weights set, 4 pieces 25101104500 (approx. 125 kg) for 350 01 103 000		350 01 103 100
<b>Fixing option M4 (Pedestal or swivel base M4 required)</b>		
Base M4, 120 kg, (for 8 plates 40 × 40 × 4 cm), 91 × 91 × 11.5 – 15.5 cm, galvanised steel (adjustable and levellable) (price without plates)		350 01 108 235
Base M4, 180 kg, (for 12 plates 40 × 40 × 4 cm), 91 × 91 × 15.5 – 19.5 cm, galvanised steel (adjustable and levellable) (price without plates)		350 01 108 335
Cover for base M4, 88 × 88 × 5 cm, brushed aluminium (imitation)		350 01 100 400
Set of castors for base M4 (maximum weight 240 kg), Ø 5 cm, H = 5.5 cm, galvanised steel		350 01 100 500
<b>³ Granite base M4, 120 kg, 90 × 90 × 17 cm, natural stone with castors</b>		
Ground socket M4, galvanised steel		350 01 226 510
Mounting plate M4/M8, 30 × 30 × 1.5 cm, galvanised steel		350 01 226 921
Mounting plate M4 special, for installation height 50 – 149 mm, galvanised steel		350 01 226 932
Mounting plate M4 special, for installation height 150 – 350 mm, galvanised steel		350 01 226 930
Mounting plate M4 for isolated grounds, installation height made to measure, high-grade steel 1.4301/304	Price on request	350 01 229 730
Wall console M4, extension 480 mm, galvanised steel		350 01 229 405
Wall console M4, extension 100 mm, galvanised steel		350 01 229 410
<b>Pedestal M4 for FORTANO</b>		
Swivel base M4 for FORTANO		350 01 220 950
<b>Slabs for base M4</b>		
Slab set, 8 pieces, 40 × 40 × 4 cm, (ca. 110 kg), concrete		350 01 226 908
Slab set, 8 pieces, 40 × 40 × 4 cm, (ca. 115 kg), 4 pieces concrete, 4 pieces in granite-look		350 01 226 909
Slab set, 12 pieces, 40 × 40 × 4 cm, (ca. 165 kg), concrete		350 01 226 907
Slab set, 12 pieces, 40 × 40 × 4 cm, (ca. 170 kg), 8 pieces concrete, 4 pieces in granite-look		350 01 226 906
<b>Protective cover made of coated, tear-resistant polyester fabric</b>		
Protective cover with zip and rod for 300 × 300		350 01 221 492
Protective cover with zip and rod for 400 × 300		350 01 221 502
<b>Miscellaneous items</b>		
Rechargeable battery light Osyryon 6 for pole Ø 30 – 50 mm, battery charger with european plug (type C) included 1 accumulator included		350 01 557 950
Rechargeable battery light Osyryon 4 for pole Ø 30 – 50 mm, battery charger with european plug (type C) included 1 accumulator included		350 01 557 910
Spare accu, 3.6 V, 2500 mAh (for Osyryon 4 & 6)		350 01 557 920

³ only suitable for smooth, joint free surface coverings

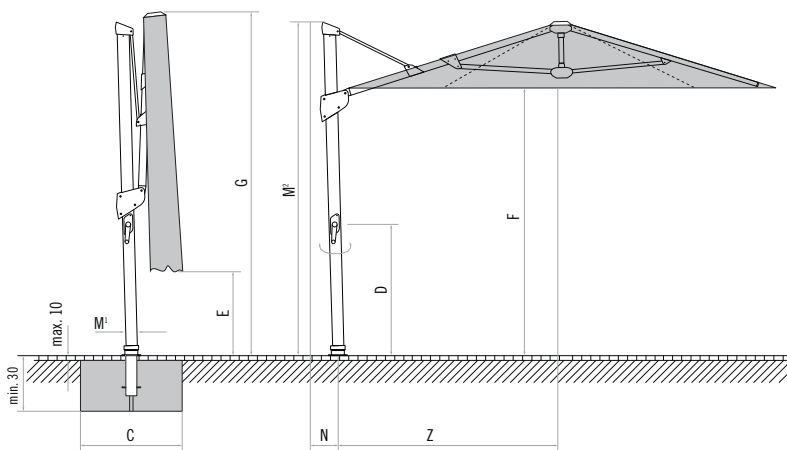

Loose cover max. 10 cm, concrete thickness min. 30 cm (pay attention to frost depth), water outflow

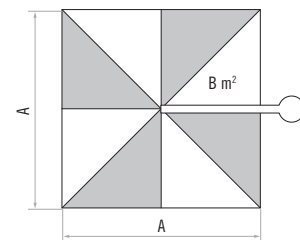

8 parts

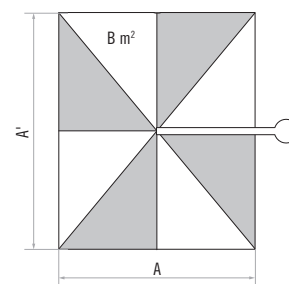

8 parts

# FORTELLO® / LED *easy*



**Frame:** 8 rods made of natural anodized aluminium, 100% inox, screws and rivets of high-grade steel, two-part profiled pole 67 × 3 mm, contrarotating opening system allowing for easy opening.

**Frame material:** anodized natural

**Frame shape:** round, rectangular or square

**Shade cover:** available in material class 2 (100% polyester approx. 220 g/m<sup>2</sup>)

**Colours:** 150

Eggshell

**Flounce:** not available

**Protective cover:** optional

**Integrated LED lighting:** 2 brightness levels (approx. 90 and 160 lx), Colour temperature approx. 3,000 K (warm white), 230 VAC, 50 Hz, 55 W incl. connector plug IP68.  
**LED is integrated into the struts. Retrofitting is not possible.**

**Fixations:**



FORTELLO®, © Int. Design reg.

## Assortment FORTELLO® / LED *easy*

Nominal size without flounce cm	Number of rods	without LED		Order no. Frame anodized natural without LED	with LED		Order no. Frame anodized natural with LED
		Material class 2 Colours 150			Material class 2 Colours 150		
Ø 450	8 parts			325 00 450 171			327 00 450 171
350 × 250 400 × 300	8 parts			325 00 352 171			327 00 352 171
	8 parts			325 00 402 171			327 00 402 171
300 × 300 350 × 350 400 × 400	8 parts			325 00 301 171			327 00 301 171
	8 parts			325 00 351 171			327 00 351 171
	8 parts			325 00 401 171			327 00 401 171

## Accessories

	Order no.
<b>Fixing option M4</b> (support tube M4 absolutely necessary)	
Base M4, 120 kg, (for 8 plates 40 × 40 × 4 cm), 91 × 91 × 11.5 - 15.5 cm, galvanised steel (adjustable and levellable) (price without plates)	350 01 108 235
Base M4, 180 kg, (for 12 plates 40 × 40 × 4 cm), 91 × 91 × 15.5 - 19.5 cm, galvanised steel (adjustable and levellable) (price without plates)	350 01 108 335
Cover for base M4, 88 × 88 × 5 cm, brushed aluminium (imitation)	350 01 100 400
Set of castors for base M4 (maximum weight 240kg), Ø 5 cm, H= 5.5 cm, galvanised steel	350 01 100 500
Ground socket M4, galvanised steel	350 01 226 510
Support tube M4, P+, galvanised steel	350 01 200 235
<b>Slabs for base M4</b>	
Slab set, 8 pieces, 40 × 40 × 4 cm, (ca. 110 kg), concrete	350 01 226 908
Slab set, 12 pieces, 40 × 40 × 4 cm, (ca. 165 kg), concrete	350 01 226 907
<b>Protective cover made of coated, tear-resistant polyester fabric</b>	
Protective cover with zip and rod, 315 × 60 cm	350 01 609 701
<b>Miscellaneous items</b>	
Rechargeable battery light Osyrion 8 for pole Ø 48–68 mm, battery charger with european plug (type C) included 1 accumulator included (not available for FORTELLO® LED <i>easy</i> )	350 01 557 960
Spare accu, 3.7 V, 4800 mAh (for Osyrion 8) (not available for FORTELLO® LED <i>easy</i> )	350 01 557 970



Nominal size	Lateral distance	Pole $\varnothing$	Area covered	Height closed	Clear headroom	Total height	Height open	Foundation	Minimum weight for base	max. wind speed open perm.
cm	cm	cm	m <sup>2</sup>	cm	cm	cm	cm	cm	kg	km/h (Bft.)
A	AS	M	B	E	F	G	H	C		
$\varnothing$ 450	415	6.7	14.3	130	215	365	290	80 × 80	120	80 (9)
350 × 250	-	6.7	8.8	125	215	350	280	80 × 80	120	100 (10)
400 × 300	-	6.7	12	130	215	375	290	80 × 80	120	85 (9)
300 × 300	-	6.7	9	125	215	345	270	80 × 80	120	100 (10)
350 × 350	-	6.7	12.3	110	215	365	280	80 × 80	120	85 (9)
400 × 400	-	6.7	16.0	95	215	385	290	100 × 100	180	75 (9)

The listed measures represent extrapolated average values that may be slightly different on the product ( $\pm 2\% \pm 5$  cm).

The height dimensions are based on the ground socket M4. With the base M4, 120 kg these vary by plus 11.5 cm and with the base M4, 180 kg by plus 15.5 cm.

The max. wind speed limits as per our separate list apply only in the presence of a fix ground anchorage.

In the presence of several sunshades, the minimum distance between one sunshade and another and between sunshades and walls shall be 20 cm.

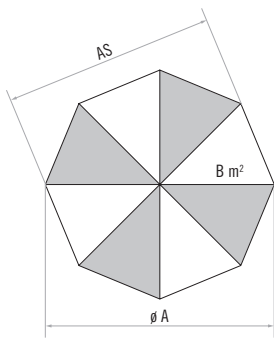

8 parts

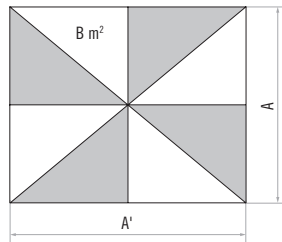

8 parts

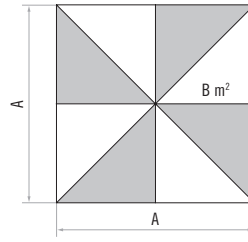

8 parts

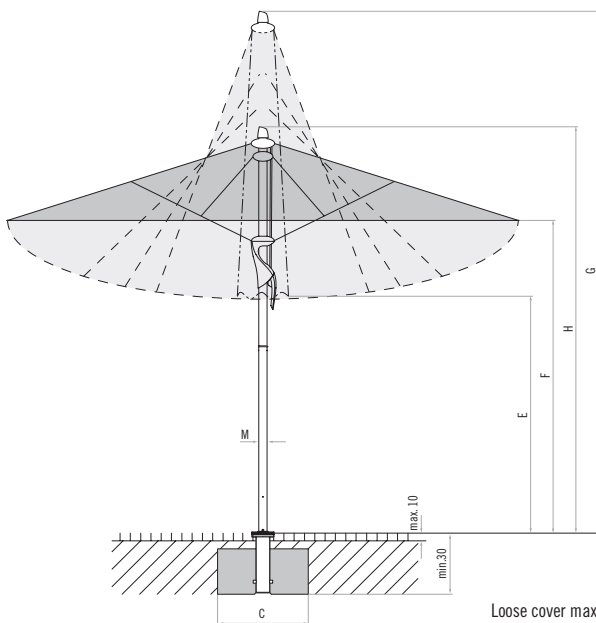

Loose cover max. 10 cm, concrete thickness min. 30 cm (pay attention to frost depth), water outflow

# SUNWING® C+ *easy*



**Frame:** 8 rods made of aluminium, with crank mechanism and integrated tilting rod for easy tilting of the shade roof up to 90° on both sides. The pole profile is round, 55 × 2.5 mm. With a removable hand crank.

**Frame material:** graphite grey powder-coated (RAL 5803 E 90070 A10)

**Frame shape:** round or square

**Shade cover:** available in material class 2 (100% polyester approx. 220 g/m<sup>2</sup>)

**Colours:**

150 Eggshell      151 Ash

**Flounce:** not available

**Protective cover:** included in the standard equipment

**Fixations:**

SUNWING® C+, © Int. Patents reg.

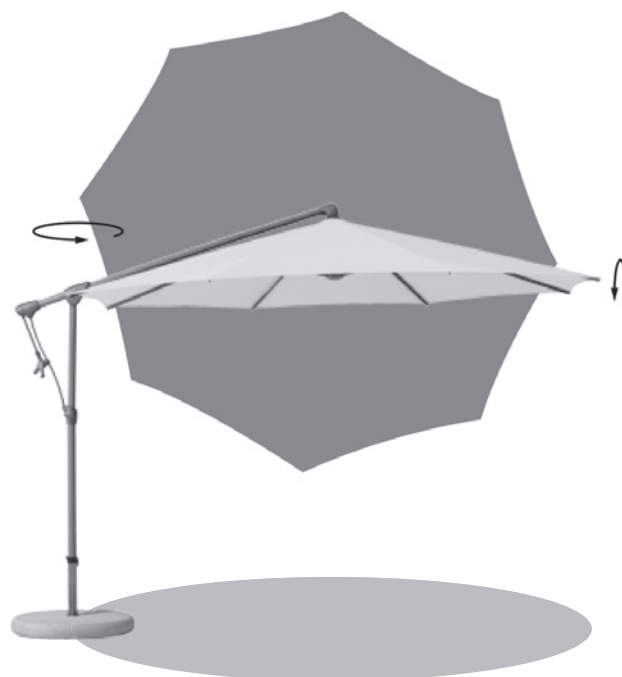

## Assortment SUNWING® C+ *easy*

	Nominal size without flounce	Number of rods	Material class 2 Colours 150 / 151	Order no.
				Frame graphite grey
○	cm			
	∅ 265	8 parts		055 00 265 321
	∅ 300	8 parts		055 00 300 321
	∅ 330	8 parts		055 00 330 321
□	260 × 260	8 parts		055 00 261 321

## Accessories

	Order no.
<b>Fixing option Z</b> (support tube Z absolutely necessary)	
Concrete base Z, 90 kg, ∅ 75 × 11 cm	350 01 109 523
Support tube Z, ∅ 48 / 55 mm, galvanised steel	350 01 201 210
Natural granite base Z, 90 kg, 64 × 64 × 9 cm, natural stone	350 01 109 515
Support tube Z, ∅ 48 / 55 mm, high-grade steel 1.4301 / 304	350 01 201 300
<b>Fixing option PX</b> (support tube PX absolutely necessary)	
Ground socket PX, galvanised steel	350 01 207 001
Connection tube PX, ∅ 48 / 55 mm, galvanised steel	350 01 206 001
<b>Fixing option M4</b> (support tube M4 absolutely necessary)	
Base M4, 120 kg, (for 8 plates 40 × 40 × 4 cm), 91 × 91 × 11.5 - 15.5 cm, galvanised steel (adjustable and levellable) (price without plates)	350 01 108 235
Support tube M4, ∅ 48 / 55 mm, galvanised steel	350 01 200 035
Ground socket M4, galvanised steel	350 01 226 510
Support tube M4, ∅ 48 / 55 mm, galvanised steel	350 01 200 035
<b>Fixing option M4</b> (support tube M4 absolutely necessary)	
Slab set, 8 pieces, 40 × 40 × 4 cm, (ca. 110 kg), concrete	350 01 226 908
<b>Protective cover made of coated, tear-resistant polyester fabric</b>	
Protective cover with zip and rod	350 01 609 982
<b>Miscellaneous items</b>	
Rechargeable battery light Osyryon 6 for pole ∅ 30 – 50 mm, battery charger with european plug (type C) included 1 accumulator included	350 01 557 950
Rechargeable battery light Osyryon 4 for pole ∅ 30 – 50 mm, battery charger with european plug (type C) included 1 accumulator included	350 01 557 910
Spare accu, 3.6 V, 2500 mAh (for Osyryon 4 & 6)	350 01 557 920
Osyryon 4 & 6 adaptor for SUNWING® C+, set of 5 pieces	350 01 557 940

Nominal size	Lateral distance	Pole Ø	Area covered	Crank height	Height closed	Clear headroom	Total height	Height of pole	Overhang at the back	Length of free-arm	Foundation	Minimum weight for base	max. wind speed open perm.
cm	cm	cm	m <sup>2</sup>	cm	cm	cm	cm	cm	cm	cm	cm	kg	km/h (wind force)
A	AS	M <sup>1</sup>	B	D	E	F	G	M <sup>2</sup>	N	Z	C		
Ø 265	245	5.5	5.0	165	105	200	290	205	70	160	60 × 60	90	30 (5)
Ø 300	280	5.5	6.4	165	85	200	290	205	70	160	60 × 60	90	30 (5)
Ø 330	305	5.5	7.7	165	70	200	290	205	70	160	60 × 60	90	30 (5)
260 × 260	-	5.5	6.8	165	55	200	290	205	70	160	60 × 60	90	30 (5)

The listed measures represent extrapolated average values that may be slightly different on the product ( $\pm 2\% \pm 5$  cm).

The measures of the height are determined by the PX ground socket. If one of the offered bases is used, these measures change only slightly.

With the base variant these vary slightly. With the variants with the ground sockets M4 and mounting plate M4 / M8, the stated height dimensions vary by 12 – 13 cm.

The max. wind speed limits as per our separate sheet apply only if the sunshade canopy is in a horizontal position and if there is a fix ground anchorage.

In the presence of several sunshades, the minimum distance between one sunshade and another and between sunshades and walls shall be 20 cm.

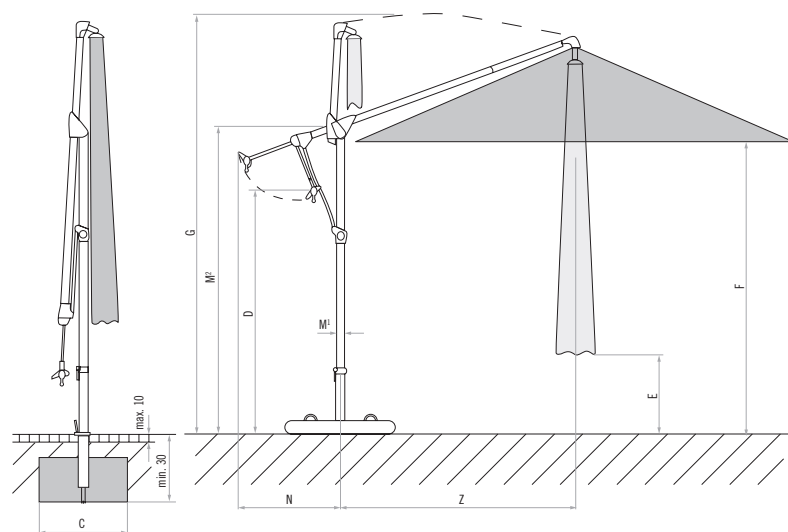
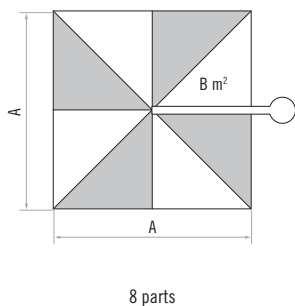
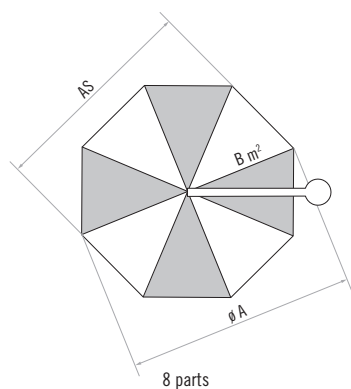

Loose cover max. 10 cm, concrete thickness  
min. 30 cm (pay attention to frost depth),  
water outflow

# SOMBRANO® S+ easy



**Frame:** 8 rods made of aluminium, with crank mechanism, (self-locking on both sides) and tilting rod for effortless tilting of the shade roof on both sides up to 54 degrees. The pole profile is oval 66 × 95 × 3 mm. M4 turnable ball-bearing base, powder-coated cast steel, is included. With a removable hand crank.

**Frame material:** graphite grey powder-coated (RAL 5803 E 90070 A10)

**Frame shape:** round, rectangular or square

**Shade cover:** available in material class 2 (100 % polyester approx. 220 g/m<sup>2</sup>)

**Colours:**

150 Eggshell      151 Ash

**Flounce:** not available

**Protective cover:** included in the standard equipment

**Fixations:**

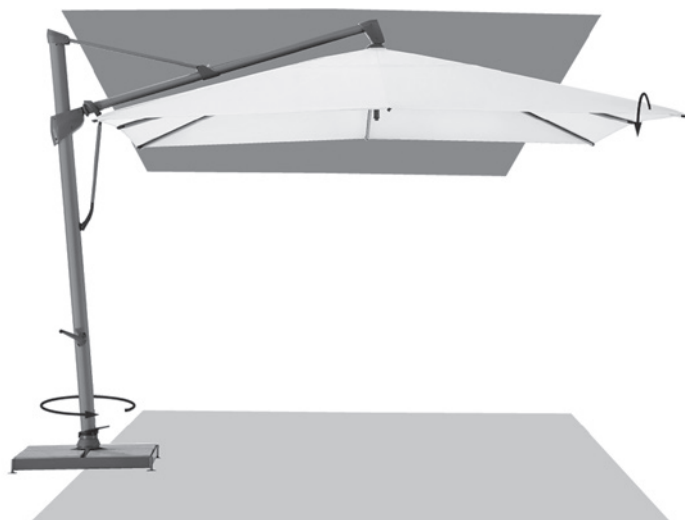

SOMBRANO®, © Int. Patents reg.

## Assortment SOMBRANO® S+ easy

	Nominal size	Number of rods	Material class 2		Order no.
	without flounce		Colours		
	cm		150 / 151		graphite grey
○	∅ 350	8 parts			085 00 350 321
	∅ 400	8 parts			085 00 400 321
□	400 × 300	8 parts			085 00 402 321
□	300 × 300	8 parts			085 00 310 321
	350 × 350	8 parts			085 00 351 321

Nominal size	Lateral distance	Pole ∅	Area covered	Crank height	Height closed	Clear headroom	Total height	Height of pole	Overhang at the back	Length of free-arm	Foundation	Minimum weight for base	max. wind speed open perm.
cm	cm	cm	m <sup>2</sup>	cm	cm	cm	cm	cm	cm	cm	cm	kg	km/h (Bft.)
A	AS	M <sup>1</sup>	B	D	E	F	G	M <sup>2</sup>	N	Z	C		
∅ 350	325	6.6 × 9.5	8.7	69	90	205	285	275	33	165	60 × 60	120	45 (6)
∅ 400	370	6.6 × 9.5	11.3	69	85	210	300	275	33	185	60 × 60	150	35 (5)
400 × 300	-	6.6 × 9.5	12	69	35	210	300	275	33	185	60 × 60	150	35 (5)
300 × 300	-	6.6 × 9.5	9.0	69	55	215	285	275	33	165	60 × 60	120	45 (6)
350 × 350	-	6.6 × 9.5	12.3	69	40	215	300	275	33	185	60 × 60	150	35 (5)

The listed measures represent extrapolated average values that may be slightly different on the product (± 2 % ± 5 cm).

The height dimensions are based on the ground socket M4. With the base M4, 120 kg these vary by plus 11.5 cm and with the base M4, 180 kg by plus 15.5 cm.

The max. wind speed limits as per our separate sheet apply only if the sunshade canopy is in a horizontal position and if there is a fix ground anchorage.

In the presence of several sunshades, the minimum distance between one sunshade and another and between sunshades and walls shall be 20 cm.

## Accessories

Order no.

### <sup>3</sup> Base with castors M4 (Weight set absolutely necessary)

<sup>3</sup> Base frame with castors M4, 150 kg, 80 × 80 × 14, galvanised steel	350 01 103 000
<sup>3</sup> Cast concrete decor weights set, 4 pieces 25101104500 (approx. 125 kg) for 350 01 103 000	350 01 103 100

### Fixing option M4

Base M4, 120 kg, (for 8 plates 40 × 40 × 4 cm), 91 × 91 × 11.5 - 15.5 cm, galvanised steel (adjustable and levellable) (price without plates)	350 01 108 235
Base M4, 180 kg, (for 12 plates 40 × 40 × 4 cm), 91 × 91 × 15.5 - 19.5 cm, galvanised steel (adjustable and levellable) (price without plates)	350 01 108 335
Cover for base M4, 88 × 88 × 5 cm, brushed aluminium (imitation)	350 01 100 400
Set of castors for base M4 (maximum weight 240kg), Ø 5 cm, H= 5.5 cm, galvanised steel	350 01 100 500
<sup>3</sup> Granite base M4, 120 kg, 90 × 90 × 17 cm, natural stone with castors	350 01 109 475
Ground socket M4, galvanised steel	350 01 226 510
Mounting plate M4 / M8, 30 × 30 × 1.5 cm, galvanised steel	350 01 226 921
Mounting plate M4 special, for installation height 50 – 149 mm, galvanised steel	350 01 226 932
Mounting plate M4 special, for installation height 150 – 350 mm, galvanised steel	350 01 226 930
Mounting plate M4 for isolated grounds, installation height made to measure, high-grade steel 1.4301 / 304	350 01 229 730
Wall console M4, extension 480 mm, galvanised steel	350 01 229 405
Wall console M4, extension 100 mm, galvanised steel	350 01 229 410

### Slabs for base M4

Slab set, 8 pieces, 40 × 40 × 4 cm, (ca. 110 kg), concrete	350 01 226 908
Slab set, 8 pieces, 40 × 40 × 4 cm, (ca. 115 kg), 4 pieces concrete, 4 pieces in granite-look	350 01 226 909
Slab set, 12 pieces, 40 × 40 × 4 cm, (ca. 165 kg), concrete	350 01 226 907
Slab set, 12 pieces, 40 × 40 × 4 cm, (ca. 170 kg), 8 pieces concrete, 4 pieces in granite-look	350 01 226 906

### Protective cover made of coated, tear-resistant polyester fabric

Protective cover with zip and rod for the SOMBRANO®, Ø 350, 300 × 300	350 01 221 492
Protective cover with zip and rod for the SOMBRANO®, Ø 400, 400 × 300, 350 × 350	350 01 221 502

### Miscellaneous items

Rechargeable battery light Osyrion 6 for pole Ø 30 – 50 mm, battery charger with european plug (type C) included 1 accumulator included	350 01 557 950
Rechargeable battery light Osyrion 4 for pole Ø 30 – 50 mm, battery charger with european plug (type C) included 1 accumulator included	350 01 557 910
Spare accu, 3.6 V, 2500 mAh (for Osyrion 4 & 6)	350 01 557 920

<sup>3</sup> only suitable for smooth, joint free surface coverings

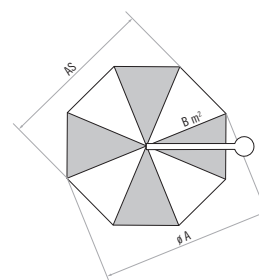
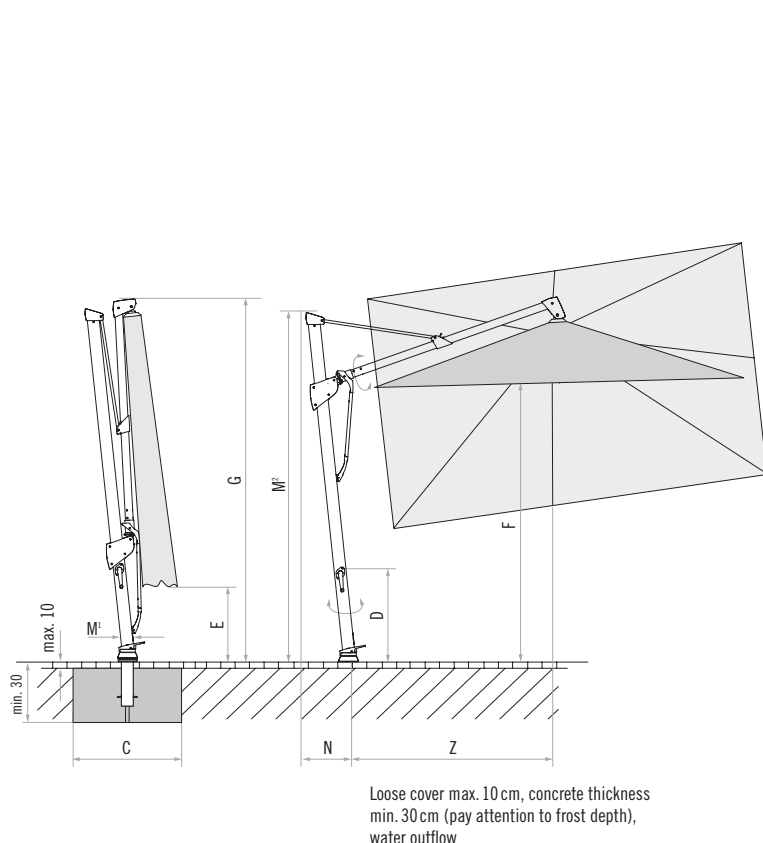

8 parts

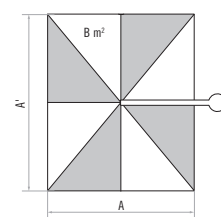

8 parts

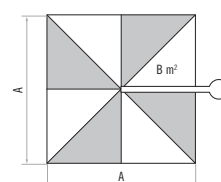

8 parts







[www.glatz.ch](http://www.glatz.ch)

**Glatz**  
Shade in Swiss Quality

Valid from 01.01.2020 until 31.12.2020.  
We reserve the right to change products.